

# PORTA DOCK

MADE *for* MEMORIES







*customer*  
**FAVORITES**

**PROUDLY MADE IN THE USA**

**5% DISCOUNT ON  
ALL DOCKS & LIFTS**  
for Veterans, Military,  
Police & First Responders

ID required. Some restrictions apply.



**ROLL-IN DOCK**

Beige Aluminum Decking, Brown Table & Chairs,  
Dock Bumpers, Handrail, Flag Pole, Solar Dock Lights,  
Canoe & Kayak Rack, Aluminum Steps



**PERFECT PAIRINGS**

Whether your looking for some lounge time or easy water access,  
our dock accessories can make it happen.



**MULTI-DOCK**  
with pads and wheels





**DROP DOWN CANOPY**  
Shown in Beige with the standard full mesh end.  
The drop panel adds an extra 30" to the canopy height for our fullest coverage.



**NEXT GENERATION FREE STANDING CANOPY**  
Shown in Black



**CANOE, KAYAK, AND PADDLE BOARD RACK**  
Fits any Porta-Dock dock.



**TRUSTED WARRANTY**

Porta-Dock offers a 15-year warranty on all aluminum construction, a 5-year warranty on all galvanized steel construction, and a 5-year warranty on all fabric canopies. For full warranty details, contact the Porta-Dock dealer nearest you.



**SWIM-UP BENCH**  
Attach directly to the side of your dock.



**DOCK BENCH**  
Perfect for lounging.



**TABLE & CHAIRS**  
Available in brown, gray, or white.



**ADJUSTABLE ALUMINUM STEPS**  
Adjust the height with ease.

# ROLL-IN DOCK

## DECKING OPTIONS

POPULAR



BEIGE  
ALUMINUM



WHITE  
ALUMINUM

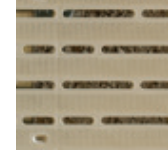

MUSHROOM  
TITAN



CEDAR



## THE ULTIMATE DOCK

Porta-Dock's Roll-In Docks are the ultimate system for your lake home or cabin. Providing unmatched in- and out-of the water capability, Porta-Dock Roll-In Docks allow for worry-free installation with minimal effort. Constructed of high-quality 6000 series aluminum or galvanized steel for maximum strength and durability, Porta-Dock Roll-In Docks are corrosion resistant and unaffected by weather conditions or UV rays. The modular design allows for endless options and additions to your dock system as your needs and budget grow.

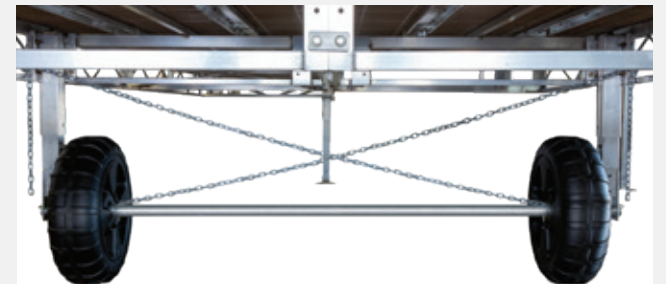

### PROVEN SUPPORT AND STABILITY

Full width axles and cross chains come standard on Porta-Dock aluminum roll-in docks.





# JUMP IN *for* ENDLESS LAKE TIME

## ALUMINUM ROLL-IN DOCK FEATURES

- Full-length truss rods for maximum strength
- Standard dual-winch system for easy leveling
- 2" galvanized full width axle
- High-density molded wheels
- Cross chains for added stability
- Vertical Lift Members (2" x 4.5" VLM) are constructed of aluminum and include a decorative cover
- Lightweight, removable decking panels sit flush within the dock's frame
- Frame center tube for added strength and decking support
- Flush mount decking provides seamless transition from decking to dock frame
- Dozens of accessory options available to fit your lifestyle

### SPECIFICATIONS

High-quality, lightweight aluminum framework allows for easy installation and years of use.

### WIDTH

4' or 5'



### THE ORIGINAL ROLL-IN DOCK

Porta-Dock was the first on the market with a Roll-In Dock in 1966.





# GALVANIZED STEEL ROLL-IN DOCK



## MAXIMUM STRENGTH DESIGN

Porta-Dock's galvanized steel Roll-In Dock system comes with the stylish look and natural beauty of cedar decking. The modular design allows for endless options when creating a dock layout that fits your exact needs. Available by sections, you can build your system as your needs and budget grow. Not available with aluminum decking.

## GALVANIZED STEEL ROLL-IN DOCK FEATURES

- Full-length truss rods for maximum strength
- 2" galvanized full width axle
- High-density molded wheels
- Frame center tube for added strength and decking support
- Modular design allows for endless options to build as your needs grow
- L-section can be assembled on the right or left side to provide an 8' x 8' or 8' x 12' platform



### BEAUTIFUL CEDAR DECKING

Stylish and durable, our cedar decking is the perfect match for our galvanized steel Roll-in Dock.

### SPECIFICATIONS

Hot dipped galvanized framework provides rustproof finish, combined with a steel reinforced frame provides maximum stability for generations.

### WIDTH

4' sections



# SAVOR *those* DOCK DAYS OF SUMMER



## OUR STRONGEST DOCK AVAILABLE AA ROLL-IN DOCK FEATURES

- Full-length truss rods for maximum strength
- Standard dual-winch system for easy leveling
- 2" galvanized full width axle
- High-density molded wheels
- Cross chains for added stability
- Vertical Lift Members (2" x 4.5" VLM) are constructed of aluminum and include a decorative cover
- Welded to frame decking panels
- Flush mount decking provides seamless transition from decking to dock frame



## DECKING OPTIONS

POPULAR



BEIGE  
ALUMINUM



WHITE  
ALUMINUM

### SPECIFICATIONS

Maximum aluminum thickness and state-of-the-art, high-quality, interlocking (tongue and groove) decking welded to the dock frame.

### WIDTH

4' or 5'



# POST DOCK



## DECKING OPTIONS



BEIGE ALUMINUM

WHITE ALUMINUM

MUSHROOM TITAN

CEDAR

### OUR MOST ECONOMICAL DOCK OPTION

Porta-Dock's Post Docks are an economical choice for any lakeshore without sacrificing quality or configuration options.



### MAXIMUM STRENGTH AND DURABILITY

Porta-Dock's Post Docks are constructed of high-quality 6000 series aluminum for maximum strength and durability. Post Docks are corrosion resistant, and unaffected by weather conditions or UV rays.



SO FUN *you'll want*  
 SUMMER TO GO  
*on* FOREVER



## POST DOCK FEATURES

- Cross bracing provides added support and stability (optional)
- Connector brackets allow for ease of post dock installation
- Available as flush or through-post design
- Under deck flush post adapter provides 18" height adjustment (optional)
- Aluminum dock posts with base pads ensure sturdiness and ease of leveling
- Dozens of accessory options available to fit your lifestyle

## SPECIFICATIONS

High-quality, lightweight aluminum framework (37 lbs) allows for easy installation and years of use.

**WIDTH**  
4' or 5'

**LENGTH**  
6' 5" or 8'





# MULTI-DOCK



## DECKING OPTIONS



SHOWN WITH PADS  
AND POSTS



SHOWN WITH PADS  
AND WHEELS

## PORTA-DOCK'S MOST VERSATILE DOCK

A true innovation, Porta-Dock's Multi-Dock combines the strength and stability of Porta-Dock's Roll-In dock with the ability to use posts or our revolutionary new leveling system. Enjoy superior stability without sacrificing ease of installation and removal.

### SPECIFICATIONS

High-quality, lightweight aluminum framework.

### WIDTH

4' or 5'







## MULTI-DOCK FEATURES

- Available as a post or roll-in dock
- Connection plate allows for ease of installation and unmatched strength
- Revolutionary screw legs with braces allow for multiple position leveling with the use of a cordless drill for maximum efficiency
- Incorporates adjustable screw legs with braces for easy leveling
- Includes standard post pockets for ease of leveling
- Dozens of accessory options available to fit your lifestyle

## **NEW** ACCESSORY TRACK

All Multi-Docks come standard with an accessory track for easy installation of accessories, no need for drilling!  
Works with all Porta-Dock dock accessories. See the dealer nearest you with questions.

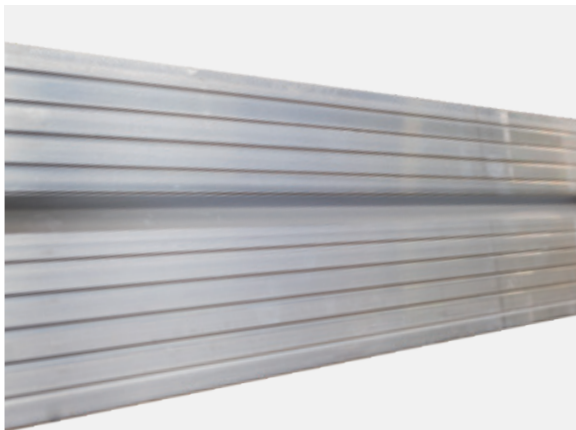

UNIVERSAL TRACK ON ALL SIDES



WORKS WITH ALL PORTA-DOCK  
DOCK ACCESSORIES



SECURES EASILY FROM UNDER  
DECK FRAME

# FLOATING DOCK

## DECKING OPTIONS



## FOR RESIDENTIAL OR COMMERCIAL USE

Porta-Dock's Floating Docks are perfect for fluctuating water conditions, muddy lake bottoms, and deep water areas. The unique design and construction allows for endless configuration options without sacrificing dock stability.

## YOUR DEEP WATER DOCK SOLUTION

Endless configurations available for any commercial or residential application. Big or small, we can make your commercial dock project a success. Contact your nearest dealer to begin the configuration process.





# FLOAT *the* SUMMER AWAY

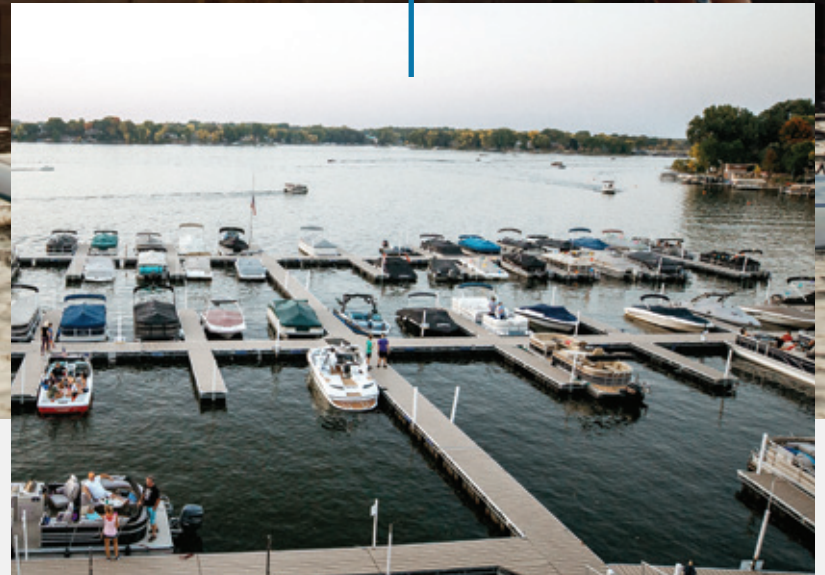

## FLOATING DOCK FEATURES

- Corrosion-resistant polyethylene foam-filled floats maintain stability in any water condition
- Friction-resistant pocket inserts 4' widths
- Hot-dipped galvanized steel frame (Commercial)
- 6000 series lightweight aluminum frame (Residential)

**WIDTH**  
4'

**LENGTH**  
8' or 16'



PROUDLY MAKING DOCKS SINCE 1966



LORE, BRICE, BOB, AND BRIAN GILLMAN CIRCA 1985

## MADE *for* GENERATIONS

### LAKE TIME HAS ALWAYS BEEN FAMILY TIME

In 1966, from the humble beginnings of his garage, Bob Gillman knew there was a better way to engineer a dock; a dock that was easier to install and could be built to last allowing families to create a generations worth of memories of time spent at the lake.

Today, the innovation that sparked the first-ever roll-in dock on the market continues through the passion of his family (pictured above). As a Midwest leader in docks, lifts and accessories, Porta-Dock's dedication remains focused on living up to Bob's commitment to products that are easy to install, easy to enjoy, and above all built to last a lifetime.



BOB GILLMAN WITH SON BRIAN CIRCA 1981



Visit your local Porta-Dock dealer for our full line of accessories including benches, ladders, steps, and bumpers.



#### HAND RAILINGS

Lightweight aluminum railings for additional safety.



#### LADDERS

Ladders available in 3-step or 4-step aluminum construction.



#### TABLE AND CHAIR SETS

Available to fit most dock options. Available in brown or white.



#### BENCH OPTIONS

SPECIFICATIONS	WIDTH	FEATURES
Perfect for lounging and attaches directly to your dock.	Fiberglass: 48"	Arm rests are also available in matching styles Available as deck mount or frame mount Available in fiberglass, aluminum, or cedar to match decking
	Aluminum: 48" and 60"	
	Cedar: 44" and 56"	



#### DECK EXTENSION

Our Deck Extension easily attaches to the side frame. Allows for easy entrance into and exit from the boat or pontoon.



#### DOCK BUMPERS

Both horizontal and vertical dock bumpers are available for all dock styles. See dealer for available colors and lengths.



#### SOLAR DOCK LIGHT

##### SPECIFICATIONS

The easiest, most convenient way to light your dock. At nightfall, the solar dock light's sensor automatically turns on the super bright LED. With multiple units, your dock will provide an elegantly lit pathway for all to walk on.

##### FEATURES

Lasts 18+ hours on a full charge  
Brighter than conventional solar garden lights  
Fits any Porta-Dock dock post with included mounting bracket  
Available in standard or flush mount



#### DOCK CLEAT

Secures to dock frame using the Porta-Dock track system. No need to drill or bolt through the decking. Non-track system option also available.



### CANOE, KAYAK, & PADDLE BOARD RACK

Porta-Dock racks make storage of your canoe, kayak, or paddle board simple and easy. Fits any Porta-Dock dock.



### FLAG POLE

Adjustable flag pole extends to 15' and allows for 3'x5' flag. Includes bracket for ease of attachment to and removal from dock frame.



### HINGES

Allows the dock to "flex" and adjust.



### ECONOMY DOCK WHEEL KIT

Easily bolting onto the side frame of your dock, our Economy Dock Wheel Kit provides additional bracing to allow for transportation over rough terrain.

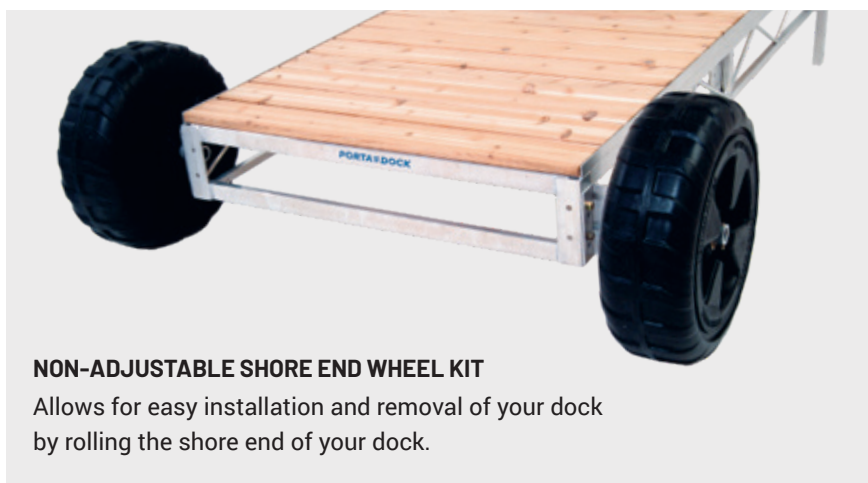

### NON-ADJUSTABLE SHORE END WHEEL KIT

Allows for easy installation and removal of your dock by rolling the shore end of your dock.



### SWIM-UP BENCH

Easy to install directly to the side of your dock. Comes in White or Beige.



### TOW BAR

Makes installation and removal of your dock easier than ever. Made for use from in-water to shore. Not intended for road use.

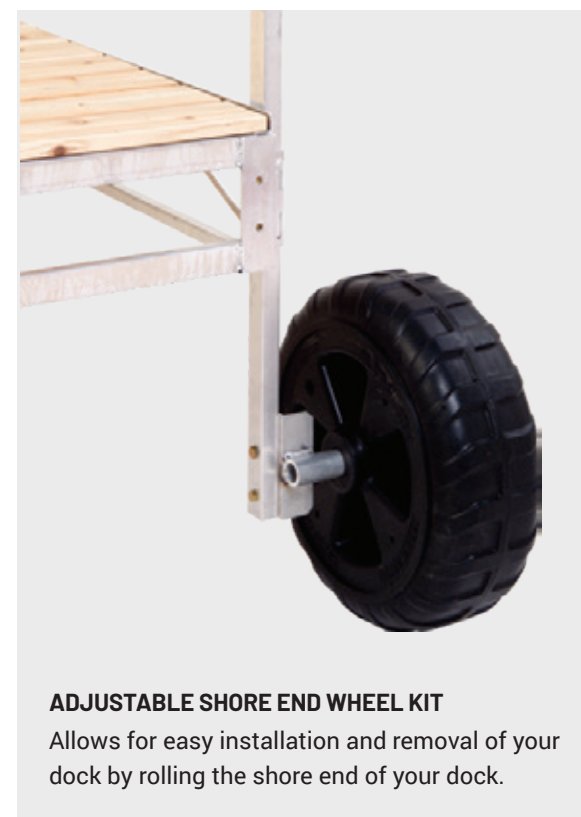

### ADJUSTABLE SHORE END WHEEL KIT

Allows for easy installation and removal of your dock by rolling the shore end of your dock.



## ALUMINUM STEPS

Some aluminum steps come standard with handrails and adjustable legs. Custom steps available. Measurements are from top step down.

### NON-ADJUSTABLE ALUMINUM STEPS



TYPE	HEIGHT
4-STEP	29" - 41"
6-STEP	45" - 57"
8-STEP	59" - 71"



### ADJUSTABLE ALUMINUM STEPS



TYPE	HEIGHT
4-STEP	Adjustable 18" - 34"
6-STEP	Adjustable 22" - 42"

## ADJUSTABLE SHORE STEPS WITH OPTIONAL PLATFORMS

TYPE	HEIGHT	FEATURES
5-STEP	Adjustable 24" - 48"	Porta-Dock's adjustable shore steps are made entirely of aluminum and are adjustable and self-leveling  All types fit any slope; available in White or Beige
8-STEP	Adjustable 30" - 58"	
10-STEP	Adjustable 38" - 74"	



### SHORE END RAMP SECTION

Available for all models of docks in 4' and 8' lengths. Hinge allows for up or down placement.



### CORNER SECTIONS

Easily add corner sections to any Porta-Dock dock to increase the square footage of your dock.



*worry less*  
**WE'VE GOT YOU  
 COVERED**



STANDARD FULL MESH END  
 DROP DOWN CANOPY



### 7000 LBS VERTICAL LIFT

Big boat or pontoon? No problem. Porta-Dock has you covered with our new 7000 lbs vertical lift. Perfect for wake boats, tri-tubes, and anything that requires the strength of a Porta-Dock.

> SEE PAGE 20 FOR SPECIFICATIONS.





## TRUSTED WARRANTY

Porta-Dock offers a 15-year warranty on all aluminum construction, a 5-year warranty on all galvanized steel construction, and a 5-year warranty on all fabric canopies. For full warranty details, contact the Porta-Dock dealer nearest you.

## NEXT GENERATION FREE STANDING CANOPY

Don't need a lift? A Porta-Dock free standing canopy provides protection from the elements when a traditional lift is not needed.



# VERTICAL LIFTS

## ONE OF THE DEEPEST CANOPIES ON THE MARKET

Our one piece canopy attaches to any Porta-Dock lift canopy to create a “garage-like” enclosure. Provides added protection to your watercraft, boat, or pontoon while in the lift. Easy to attach by mounting to existing canopy frame. Our optional mesh canopy allows for deeper coverage while still allowing for air to pass through.



SHOWN WITH  
OPTIONAL 30" DROP



STANDARD FULL  
MESH END

## LIFTS MADE FOR ANY SIZE

Porta-Dock offers a complete line of aluminum Boat and Pontoon Lifts designed and engineered with features that make each lift work with your boat or pontoon. Constructed of high-quality 6000 series aluminum for maximum strength and durability, our lifts are rustproof, corrosion resistant, and unaffected by weather conditions or UV rays. In addition, bunk assemblies adjust both vertically and horizontally for maximum boat support.

- Deluxe Pontoon Bunks (DPB)
- Full Pontoon Bunks (FPB) Tri-Tube
- Full Length Bunks (FLB)
- Economy V Bunks (EVB)
- Full Pontoon Bunks (FPB) Standard

## VERTICAL LIFTS

LIFT TYPE	MODEL	BEAM	BED LENGTH	MAX CAP.	WEIGHT
Vertical	<b>30120</b>	120"	9	3000 lbs	345 lbs
Vertical	<b>40120 Standard</b>	120"	9	4000 lbs	395 lbs
Vertical	<b>40120 Long</b>	120"	11	4000 lbs	405 lbs
Vertical	<b>45120</b>	120"	11	4500 lbs	469 lbs
Vertical	<b>50120</b>	120"	11	5000 lbs	485 lbs
Vertical	<b>60120</b>	120"	11	6000 lbs	608 lbs
Vertical	<b>70120</b>	120"	15	7000 lbs	708 lbs
XL Vertical	<b>50120</b>	120"	15	5000 lbs	495 lbs
XL Vertical	<b>60120</b>	118"	15	6000 lbs	618 lbs
XL Vertical	<b>70120</b>	117.5"	15	7000 lbs	708 lbs
XL Vertical	<b>70144</b>	144"	15	7000 lbs	708 lbs



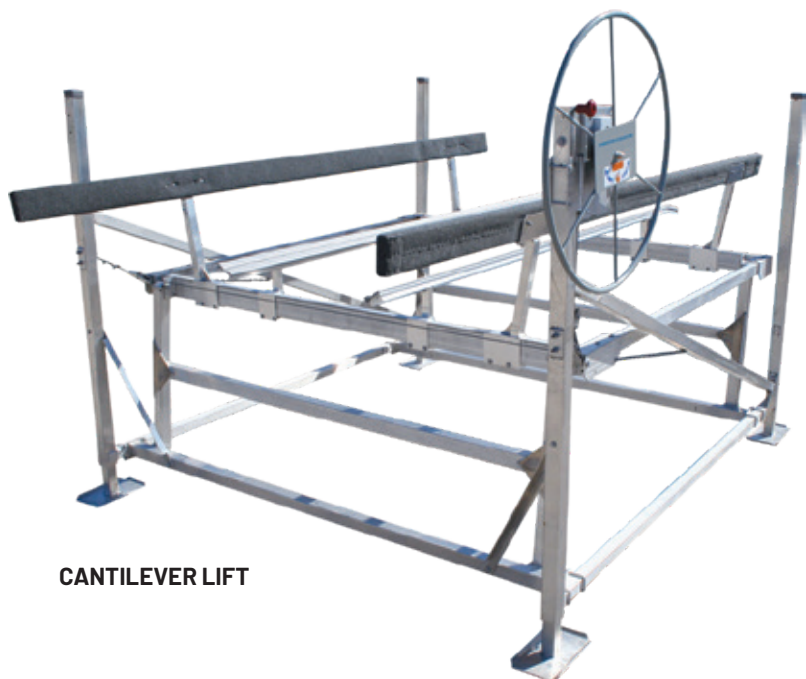

CANTILEVER LIFT



SHALLOW WATER LIFT

## CANTILEVER LIFTS

LIFT TYPE	MODEL	BEAM	MAX CAP.	WEIGHT
Cantilever	1284	84"	1200 lbs	200 lbs
Cantilever	2095	95"	2000 lbs	347 lbs



## SHALLOW WATER LIFTS

LIFT TYPE	MODEL	BEAM	BED LENGTH	MAX CAP.	WEIGHT
Shallow Water (Vertical)	30120	120"	9	3000 lbs	355 lbs
Shallow Water (Vertical)	40120 Standard	120"	9	4000 lbs	405 lbs
Shallow Water (Vertical)	40120 Long	120"	11	4000 lbs	415 lbs
Shallow Water (Vertical)	50120	120"	11	5000 lbs	518 lbs
Shallow Water (Vertical)	50120 Long	120"	15	5000 lbs	495 lbs

## LIFT FEATURES

- All four legs are adjustable - making it easy to set proper depth (optional screw legs available)
- Extruded aluminum bunk assemblies with ribbed polyurethane bunk covers on Deluxe Pontoon Bunks (FLB/FPB)
- Chain or gear drive winch comes standard with self braking for safe and easy operation
- Low maintenance
- Maintenance free bunks available on 3000–6000 lb. lifts
- Stainless steel cables
- Lightweight aluminum frame
- Enclosed pulleys
- 66" maximum lifting height
- Lift wheel included on all models
- Canopies available (see page 24)
- Optional motor stop (see page 25)



## SHALLOW WATER LIFT SOLUTION

Porta-Dock's Shallow Water Lifts require a minimum 6 3/4" water depth.

# PERSONAL WATERCRAFT LIFTS

## STORE & PROTECT YOUR FUN ON THE WATER

We offer a complete line of low maintenance, stylish Personal Watercraft Lifts with adjustable bunk systems and self-braking winches for safe and easy lifting. Porta-Dock's compact, light, and universal lifts are perfect for all models of watercraft. Constructed of high-quality 6000 series aluminum for maximum strength and durability, our lifts are rustproof, corrosion resistant, and unaffected by weather conditions or UV rays.

> SEE PAGE 24 FOR CANOPY COLORS

### 1155 DOUBLE PERSONAL WATERCRAFT LIFT FEATURES

- 2,200 lb lift capacity (1,100 lb per side)
- Continuous lower frame provides rigid support 55" beam per side
- Includes winches for independent raising and lowering
- Vinyl covered aluminum bunks
- 4 adjustable legs
- Lift wheel included

#### SPECIFICATIONS

LIFT TYPE	MODEL	BEAM	MAX CAP.	WEIGHT
Double	1155	55"	2200 lbs (1100/side)	336 lbs



1155 DOUBLE PERSONAL WATERCRAFT LIFT



### INDUSTRIAL STRENGTH PULLEY SHEAVE

All Porta-Dock lifts now come standard with an industrial strength pulley sheave that provides smoother and quieter operation while extending the life of the lift cable.







### 1056 CANTILEVER PERSONAL WATERCRAFT LIFT FEATURES

- 1,000 lb lift capacity
- 56" beam
- Vinyl covered aluminum bunks
- 4 adjustable legs
- Lift wheel included

#### SPECIFICATIONS

LIFT TYPE	MODEL	BEAM	MAX CAP.	WEIGHT
Cantilever	<b>1056</b>	56"	1000 lbs	136 lbs



### 1265 CANTILEVER / VERTICAL PERSONAL WATER CRAFT LIFT FEATURES

- 1,200 lb lift capacity
- 65" beam
- Vinyl covered aluminum bunks
- 4 adjustable legs
- Lift wheel included

#### SPECIFICATIONS

LIFT TYPE	MODEL	BEAM	MAX CAP.	WEIGHT
Cantilever	<b>1265</b>	65"	1200 lbs	200 lbs
Vertical	<b>1265</b>	65"	1200 lbs	185 lbs

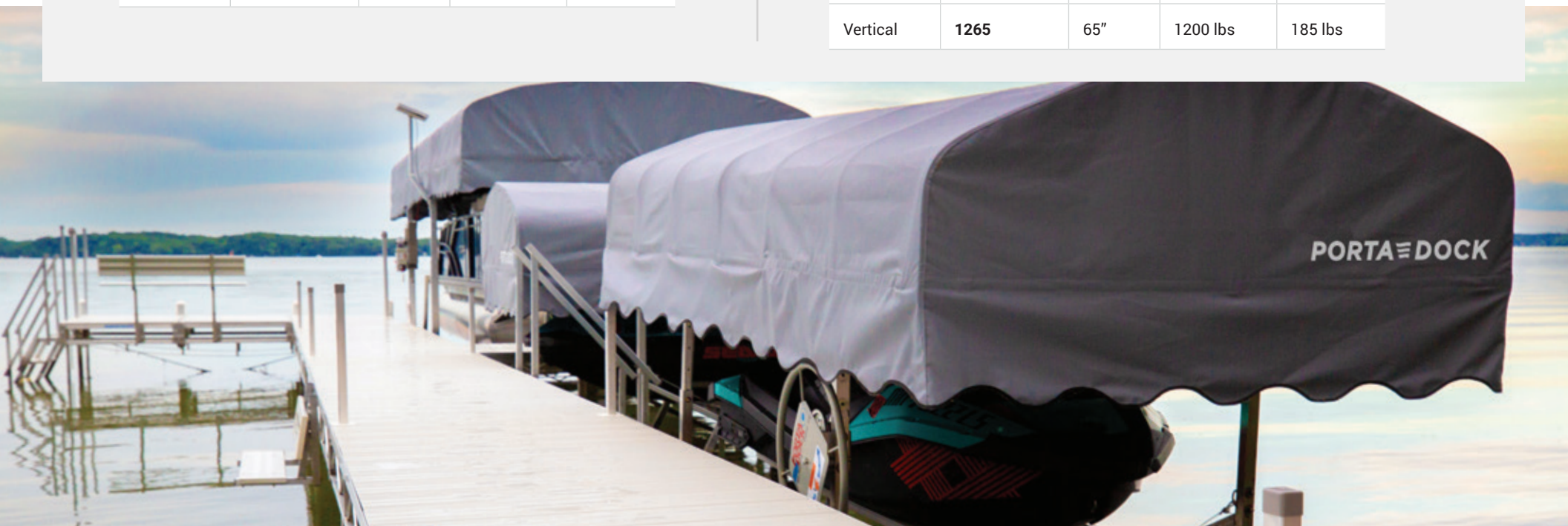



See the dealer nearest you for a list of all accessories or visit [www.Porta-Dock.com](http://www.Porta-Dock.com)

# CRAFTED *for the lake* BUILT TO LAST



## DROP DOWN CANOPY

Our one piece canopy attaches to any Porta-Dock lift canopy to create a “garage-like” enclosure. It provides added protection to your watercraft, boat, or pontoon while in the lift. Easy to attach by mounting to existing canopy frame. Our standard full mesh end canopy allows for deeper coverage while still allowing for air to pass through.

## CANOPY FEATURES

- Adjustable aluminum framework
- Double aluminum tubing runs the full length of the top
- Heat-sealed creating strong, long-lasting seams
- TOP GUN® acrylic coated polyester marine fabric
- Easily cleans with mild detergent and water
- Comes standard with a full-mesh end (on boat and pontoon lift canopies only)



### BATTERY TRAY CANOPY MOUNTED

A battery bracket that allows a 12 volt battery to be mounted onto a Porta-Dock canopy. Keeps a battery for a DC power unit off your dock. Fits all Porta-Dock canopies.

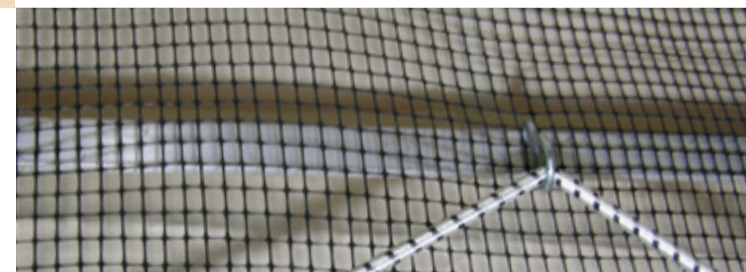

### BIRD PROOF NETTING

Durable, lightweight, rot resistant and waterproof mesh prevents birds of all species from nesting under your canopy. Installs in minutes.



BEIGE



CHARCOAL

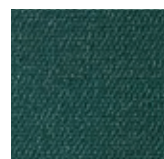

FOREST GREEN

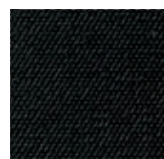

ONYX BLACK

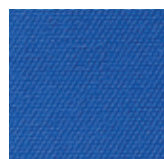

CARIBBEAN BLUE

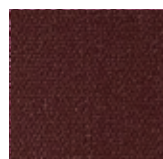

BURGUNDY

## CANOPY COLORS

All Porta-Dock TOP GUN® and vinyl canopies come with a 5-year warranty and the canopy offers maximum depth, giving your boat exceptional protection from the elements.



## LIFT STEP

Get in and out safer and easier.



## GUIDE ONS

Full-length padded guide-ons aid in proper boat placement on lift.

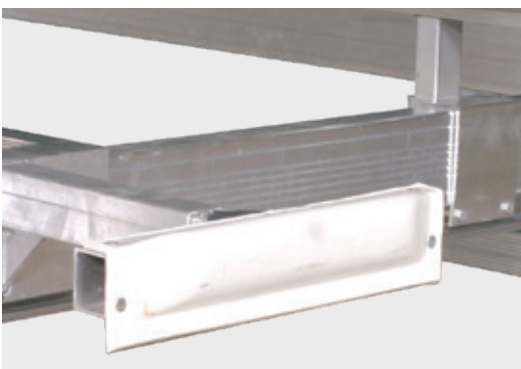

## MOTOR STOP

Ensures the safety of your lift and motor.



## BOAT STOP

Prevents your boat from overrunning the lift.

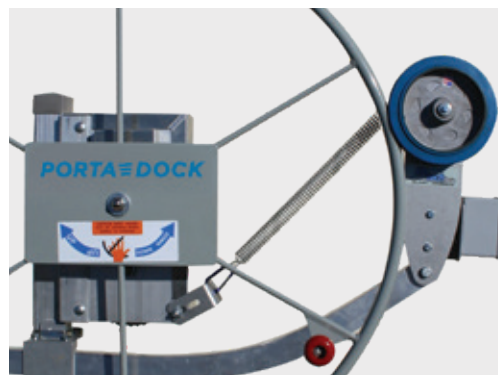

## MOTORIZED WINCH KIT

Designed for optimum strength and ease of use, each motorized winch kit removes the strain from your lift and provides generous clearance and access. Adapts to existing lifts. Available as 12, 24, or 110 volt power. Remotes and solar panels optional on most models. See dealer for details. Available as a manual or auto stop without a key fob.



## PONTOON STOPS

Assists in positioning your boat into the proper location on the lift. Adjustable to accommodate any style of boat.



## MAINTENANCE-FREE PONTOON GUIDE

Assists in positioning your boat into the proper location on the lift.

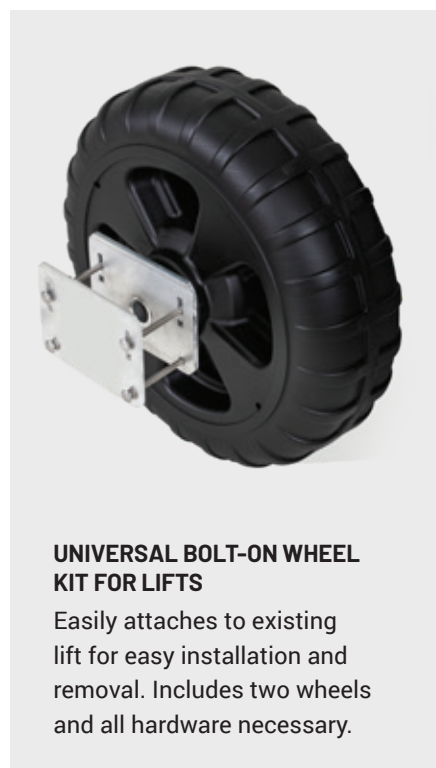

## UNIVERSAL BOLT-ON WHEEL KIT FOR LIFTS

Easily attaches to existing lift for easy installation and removal. Includes two wheels and all hardware necessary.

## 12 & 24 VOLT WATT SOLAR PANEL SYSTEMS

Our solar charging systems are made from high quality, more efficient Monocrystalline Solar Cells that also provide a clean, uniform look. Each panel is enclosed in a screw-less anodized aluminum frame and tempered glass with a water tight junction box and blocking diodes.

\*Mounting arm and brackets included



## ENDLESS CONFIGURATIONS



SW  
STRAIGHT DOCK

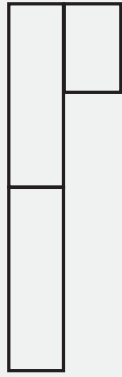

L-8  
8X8 END

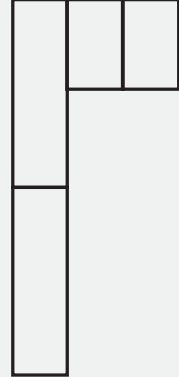

L-12  
8X12 END

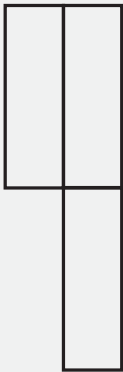

8' SUNDECK  
8X16

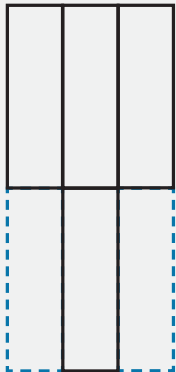

12' SUNDECK  
12X16

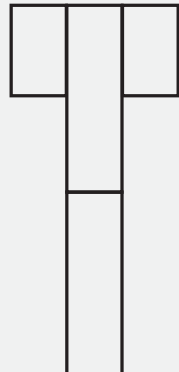

T-12  
8X12

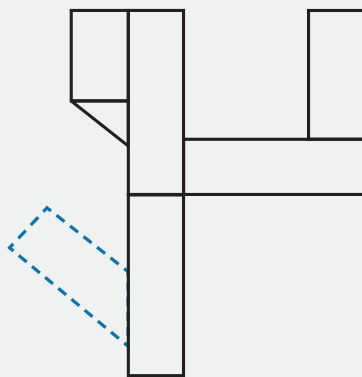

U-SHAPED  
8X12

VISIT [PORTA-DOCK.COM](http://PORTA-DOCK.COM) TO CONFIGURE A LAYOUT PERFECT FOR YOUR LIFESTYLE.

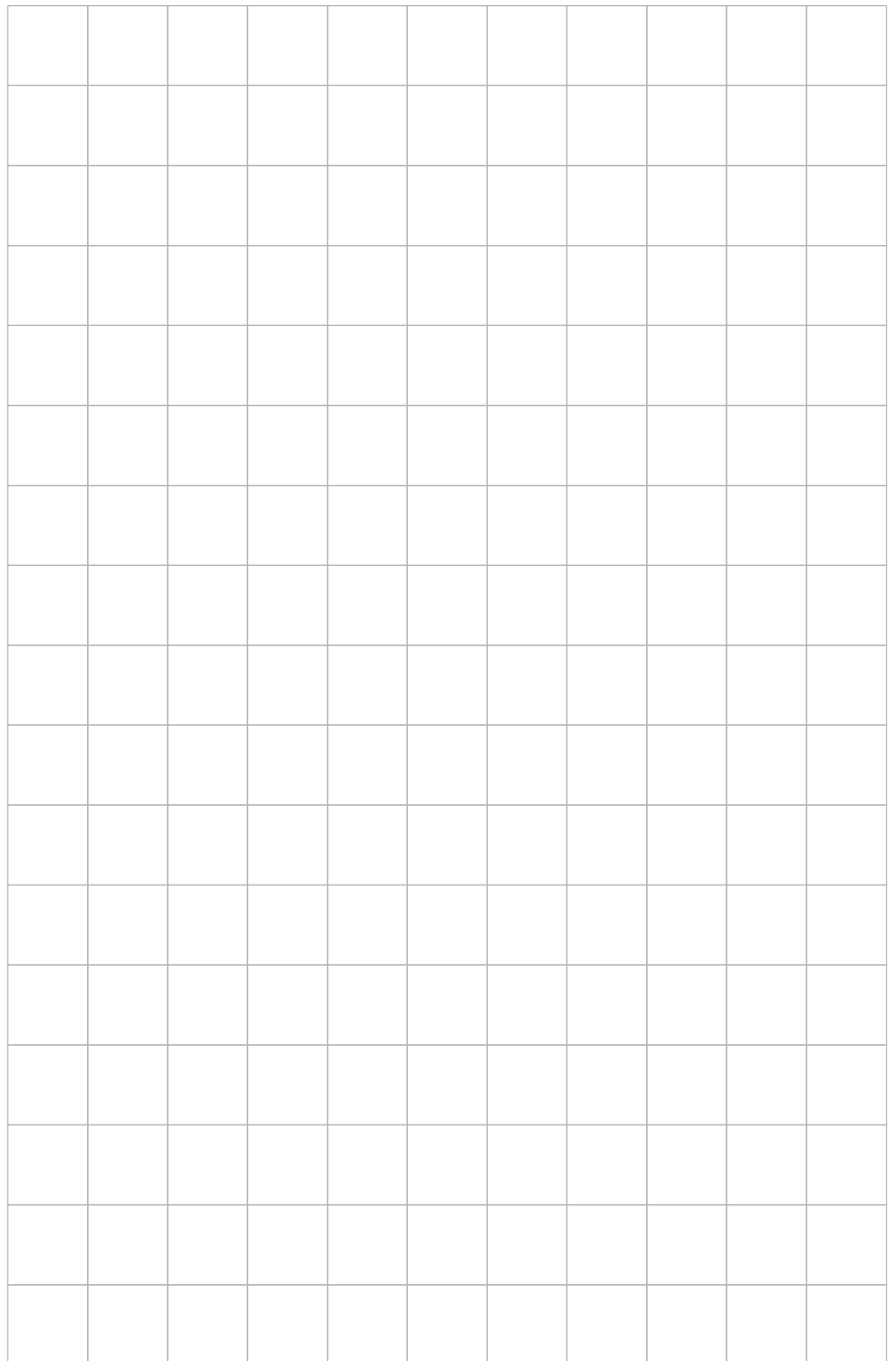

1 grid square = 1/2"



**POST DOCK**



**ROLL-IN DOCK**



**MULTI-DOCK  
with pads**



**GALVANIZED STEEL  
ROLL-IN DOCK**

**MULTI-DOCK  
with pads and wheels**



**AA ROLL-IN DOCK**





FIND YOUR LOCAL DEALER:  
[PORTA-DOCK.COM](http://PORTA-DOCK.COM)



**PORTA  DOCK**

[PORTA-DOCK.COM](http://PORTA-DOCK.COM)



ALL PORTA-DOCK PRODUCTS ARE  
MADE IN DASSEL, MN, U.S.A.



FOLLOW US ON FACEBOOK,  
INSTAGRAM, AND YOUTUBE